

Modelling of Rowing Dynamics Using Mixed Reality Bond Graphs

Yong-Ho Yoo

Bremen University, Germany

Research Center for Work, Environment and Technology (artecLab)

Enrique-Schmidt-Straße 7 (SFG)

D-28334 Bremen

yoo@artec.uni-bremen.de

Abstract: The aim of this paper is to present a modelling of rowing dynamics using bond graphs and to replace it by a modelling of mixed reality rowing dynamics using *Mixed Reality Bond Graphs*. Continuous-time dynamics for real environments, discrete-time dynamics for virtual environments, and their *Hyper-Bond* interfaces in a mixed reality rowing dynamics will be described together using the mixed reality bond graphs, and this dynamics will be simulated in 20-sim, a simulation program of bond graph notations of standard mechatronic models.

1 Introduction

How to develop usability supported by more physical phenomena has been an active topic in mixed reality. Dix et al. [Dix04, Gah04] claimed the naturalness of physical interaction in the concept of Fluidity. Since the energy exchange is an important natural phenomenon in the real world, the energy-based approach of mixed reality may be extremely useful to serve natural usability of physical interaction in mixed reality. The *Bond Graph* [Pay61, Ka90] methodology is an energy-based approach which provides a unified and domain-independent design aspect of several physical phenomena. The bond graphs were extended to the *Mixed Reality Bond Graphs* [Yoo07] to describe mixed reality dynamics where continuous-time bond graphs ('A' in Figure 1) for real environments are connected with discrete-time bond graphs ('B*' in Figure 1) for virtual environments via energy interfaces called *Hyper-Bonds* ('HB' in Figure 1) [Bru01, Yoo06]. The aim of this paper is to present a modelling of rowing dynamics using bond graphs and to replace it by a modelling of mixed reality rowing dynamics using mixed reality bond graphs. Continuous-time dynamics for real environments, discrete-time dynamics for virtual environments, and their hyper-bond interfaces in a mixed reality rowing dynamics will be described together using the mixed reality bond graphs, and these dynamics will be simulated in 20-sim, a simulation program of bond graphs and standard mechatronic models [Am04].

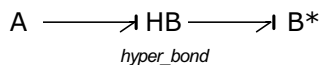

Figure 1: The concept of Mixed Reality Bond Graphs

2 Modelling of 1D and 2D Rowing Dynamics

In this section, the rowing dynamics of a canoe such as in Figure 2, with one oar for 1D (one dimensional) rowing, is demonstrated, and it is extended to 2D rowing dynamics with two oars. Assuming that the canoe is moved only by the rowing force from the rower, I_{oar1} is the inertia of the oar on the inside of the canoe, e_{oar1} and f_{oar1} are the force and velocity from the rower, I_{oar2} is the inertia of the oar on the outside of the canoe, $R_{oar-water}$ is the friction between the oar and water rowing, e_{oar2} and f_{oar2} are the force and velocity of the oar in the water, I_{canoe} is the inertia of the canoe, $R_{canoe-water}$ is the friction between the canoe and water, and e_{canoe} and f_{canoe} are the force and velocity. The rowing power from the rower is the sum of power to move the canoe and oar. This rowing dynamics can be described by bond graphs such as in Figure 3.

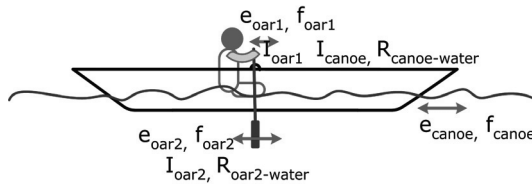

Figure 2: Rowing dynamics of a canoe with one oar for 1D rowing.

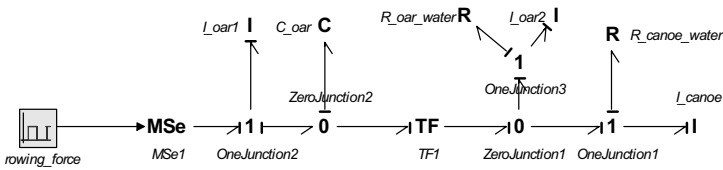

Figure 3: The bond graph description of the rowing dynamics.

where $1/C_{oar}$ is the stiffness of the oar, TF_1 is the transformer of the oar. Figure 4 shows a simulation of this rowing dynamics using bond graphs in 20-sim [Am04]. For this simulation, the following values have been selected in some anticipation of a real rowing model: I_{oar1} is $0.1 \text{ N-s}^2/\text{m}$, I_{oar2} is $0.2 \text{ N-s}^2/\text{m}$, I_{canoe} is $5 \text{ N-s}^2/\text{m}$, $R_{canoe-water}$ is 5 N-m-s , $R_{oar-water}$ is 1 N-m-s , C_{oar} is 0.0001 m/N , and TF_1 is 2. The input of rowing force is the square train which has a period of π rad: 1 N under the water during first $\pi/2$ rad and 0 N upper the water during next $\pi/2$ rad—note that the force for returning the oar upper the water is not considered in this dynamics.

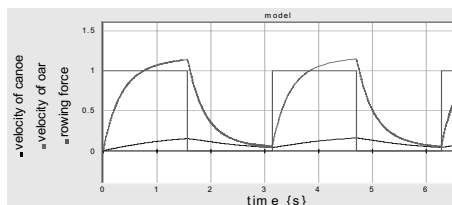
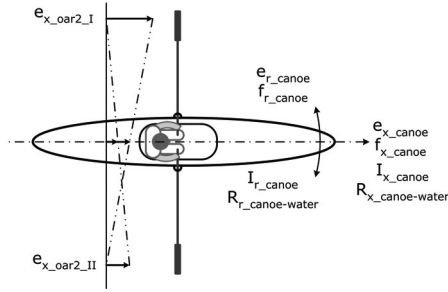

Figure 4: Simulation of the rowing dynamics.

3 Modelling of Mixed Reality 2D Rowing Dynamics

Now, let us extend these dynamics to the 2D rowing dynamics. Figure 5 shows a canoe which has two oars. The canoe can be rowed to the x-direction (forward/backward velocity: f_{x_canoe}) and to the r-direction (rotational: f_{r_canoe}); it has the inertia and friction (I_{x_canoe} and $R_{x_canoe-water}$) to the x-direction and the inertia and friction (I_{r_canoe} , $R_{r_canoe-water}$) to the r-direction. The force (e_{x_canoe}) of the canoe to the x-direction and the turning force (e_{r_canoe}) of the canoe to the r-direction can be calculated as Eq. 1 and Eq.2.



$$e_{x_canoe} = \frac{e_{x_oar_I} + e_{x_oar_II}}{2} \quad (1)$$

$$e_{r_canoe} = e_{x_oar_I} - e_{x_oar_II} \quad (2)$$

where $e_{x_oar2_I}$ and $e_{x_oar2_II}$ are forces at the oars against the water.

Figure 5: 2D rowing dynamics

As the 2D rowing dynamics (Figure 5) is replaced by mixed reality rowing dynamics, it can be described using mixed reality bond graphs such as in Figure 6: The oars are considered as the points of energy coupling between real/virtual dynamics; the transformer m is 2 from Eq. 1; 'name of element_I' means the elements of the first oar; 'name of element_II' means the elements of the second oar; 'part A' describes the dynamics of real oar1_I/II; 'part B' describes the dynamics of virtual oar2_I/II, virtual canoe, and virtual water. ZeroJunction2 is connected by a hyper-bond with TF1* and also ZeroJunction4 is connected by a hyper-bond with TF3*. The rowing power from the rower is the sum of power to move the oars and canoe to x/r-directions.

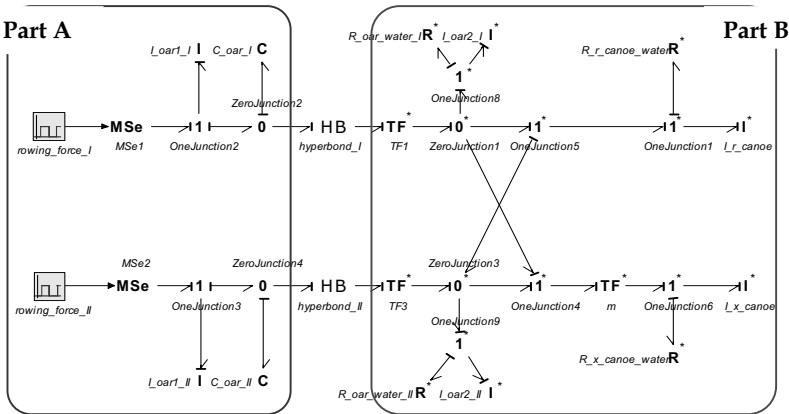

Figure 6: Mixed reality bond graphs of 2D mixed reality rowing dynamics: $I_{x_canoe}^*=5 \text{ N-s}^2/\text{m}$, $R_{x_canoe-water}^*=5 \text{ N-m-s}$, $I_{r_canoe}^*=10 \text{ N-s}^2/\text{m}$, $R_{r_canoe-water}^*=10 \text{ N-m-s}$, $I_{oar1_I}=I_{oar1_II}=0.1 \text{ N-s}^2/\text{m}$, $I_{oar2_I}=I_{oar2_II}=0.5 \text{ N-s}^2/\text{m}$, $TF_1^*=TF_3^*=1$, $C_{oar1}=C_{oar2}=0.0001 \text{ m/N}$, and $TF_m^*=0.5$

Since it is available to transform from discrete-time dynamics in mixed reality bond graphs to discrete transfer functions [ref. Yoo06], the mixed reality bond graphs of Figure 6 can be described such as in Figure 7: *flow_OneJunction1* outputs the velocity of the canoe to r-direction and *flow_OneJunction6* outputs the velocity of the canoe to x-direction.

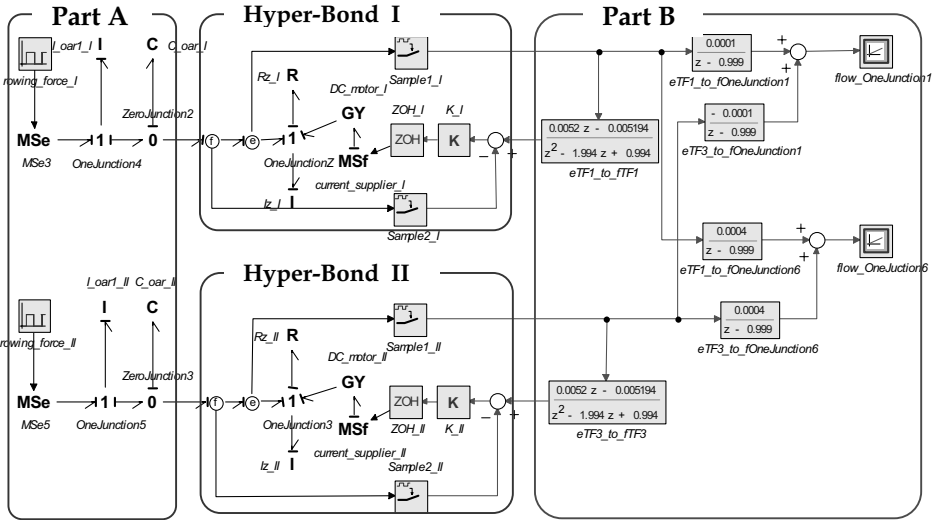
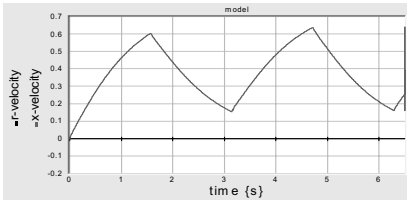
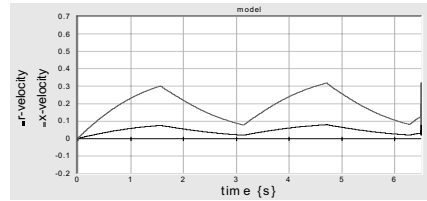

Figure 7: Implementation in 20-sim.



(a) rowing force I = 1, rowing force II = 1



(b) rowing force I = 1, rowing force II = 0

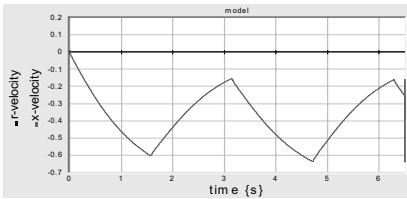

(c) rowing force I = -1, rowing force II = -1

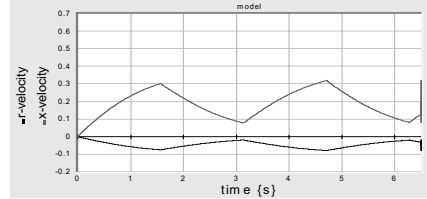

(d) rowing force I = 0, rowing force II = 1

Figure 8: Simulation of the x/r-velocity of the canoe: (a) shows forward rowing; (b) shows forward/right rowing; (c) shows backward rowing; (d) shows forward/left rowing.

Both hyper-bonds have the same construction and are selected in the definition of hyper-bond interface [Yoo07]: DC motor (GY), Rz_I/II (11 N-m-s), and Iz_I/II (1 N-s²/m) are connection impedance; current supplier (MSf) is flow generator; K_I/II (10) is the gain for error control; sampling rate is 0.001s.

The x/t-velocity behaviours of the canoe of four different inputs (rowing forces) to the oars are simulated in 20-sim (Figure 8): giving the same rowing force to both oars in the same direction, the canoe is rowed only forward or backward (Figure 8a or Figure 8c); giving a rowing force only to the oar_I in the forward direction, the canoe is rowed forward and makes a right turn (Figure 8b); giving a rowing force only to the oar_II in the forward direction, the canoe is rowed forward and makes a left turn (Figure 8d). Thus, these simulation results show a good approximation to 2D simplified rowing behaviours of an ordinary canoe in the real world.

4 Conclusion

In this paper, a modelling of mixed reality rowing dynamics is presented as an application using the *Mixed Reality Bond Graphs* methodology. Traditional bond graphs are continuous descriptions which contain all information needed to derive differential equations. However, virtual signals and systems have discrete-time dynamics on the digital computer, namely that traditional bond graphs for virtual environments are incomplete representations because they do not contain discrete-time dynamics which can directly run on the digital computer. Such problem can be solved by using mixed reality bond graphs where continuous-time bond graphs for real environments are connected with discrete-time bond graphs for virtual environments via hyper-bond interfaces.

References

- [Am04] Amoerongen, J. V.; Breedveld, P.: Modelling of Physical Systmes for the Design and Control of Mechatronic Systems. IFAC, Professional Brief, Oxford, UK, 2004.
- [Bru01] Bruns, F. W.: Hyper-Bonds (Enabling Mixed Reality), volume 82. artec-paper, Bremen University, 2001.
- [Dix04] Dix, A.; Finlay, J.; Abowd, G.; Beale, R.: Human-Computer Interaction, Third Edition. Prentice Hall, 2004.
- [Gha04] Ghazali, M. et. Al.: Fluid Interaction with Physical Devices: mining the ordinary to design the extraordinary. Equator All-Hands Meeting, Bristol, 2004.
- [Ka90] Karnopp, D. C.; Margolis, D. L., Rosenberg, R. C.: System Dynamics – A unified Approach, John Wiley, New York, 1990.
- [Pay61] Paynter, H. M.: Analysis and Design of Engineering Systems. MIT Press, Cambridge, MA, 1961.
- [YB06] Yoo, Y. H.; Bruns, F. W.: Energy Interface for Mixed Reality. Proc. 12th IFAC Symposium on Information Control Problems in Manufacturing, Saint Etienne, 2006.
- [Yoo07] Yoo, Y. H.: Mixed Reality Design Using Unified Energy Interfaces, Dissertation, Mathematic & Informatic, University of Bremen, Shaker Verlag, 2007.